

INSTALLING ADHESIVE TRANSFER TAPE

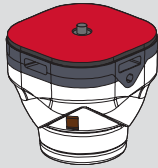

NOTES BEFORE INSTALLING: Do not overtighten screws. Overtightening screws may damage the threads on devices and MTI products. Disable alarm before installation and enable alarm after installation is complete.



M0354 - Freedom Micro® Puck

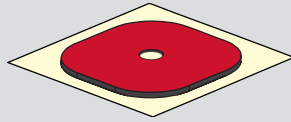

M0028 - Replacement Puck VHB

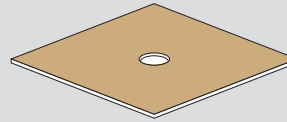

M0126 - Adhesive Transfer Pad (1)

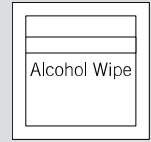

M0056 - Alcohol Wipe (1)

1 Clean the demo device with an alcohol swab and let air dry or wipe dry with a clean cloth.

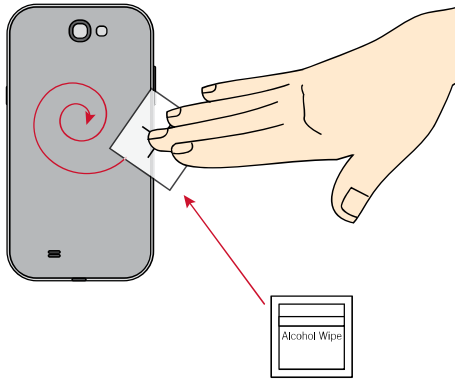

2 If using a new Puck, peel the red film from the VHB adhesive.

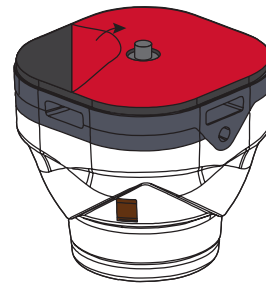

3 If using a Puck that has previously merchandized a device, replace all existing VHB before peeling the red film.

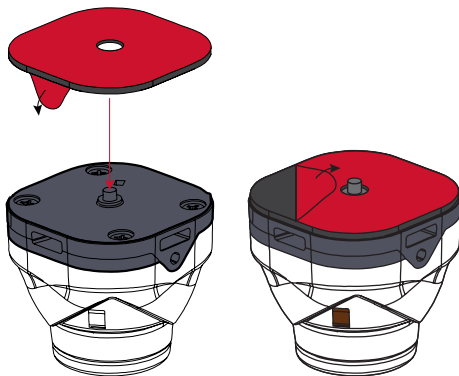

4 Adhere transfer tape to the puck without removing wax paper.

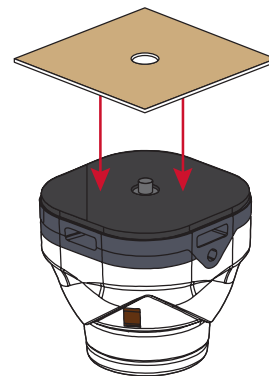

5 Remove wax paper from transfer tape and adhere to device.

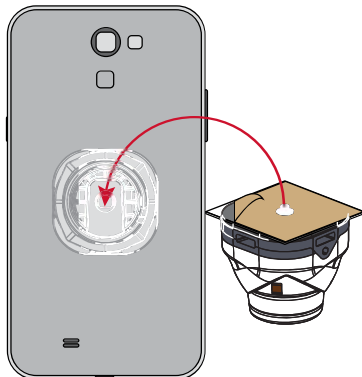

6 After allowing 24 hours for full VHB adhesion, re-attach the AirTether to the puck. Slide the thin end of the gray connector into the puck. Listen for the puck to click and lock into place.

